

© THIS DRAWING IS THE EXCLUSIVE PROPERTY OF ROBERT BOSCH GMBH. WITHOUT THEIR CONSENT IT MAY NOT BE REPRODUCED OR GIVEN TO THIRD PARTIES.

**KOMPAKT 4 2 WAY
WITH CPA**
SECONDARY LOCKING OPEN
CPA OPEN

**Kompakt 4 2polig
mit CPA**
Sekundärverriegelung offen
CPA offen

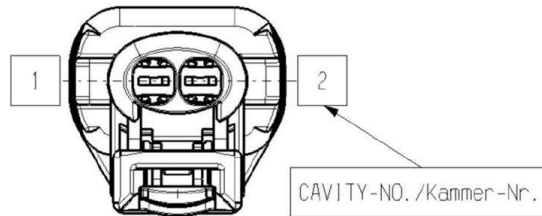
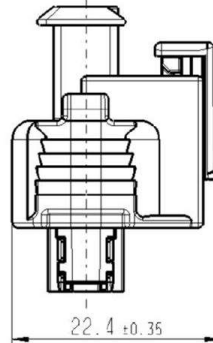
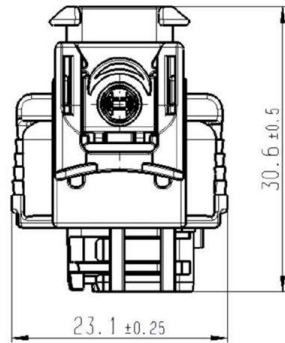
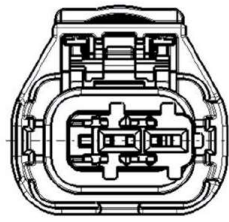

CODE I

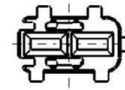

CODE II

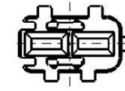

CODE III

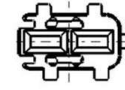

CODE IV



***) ATTENTION: SAMPLE PARTS NO. ONLY VALID FOR B-SAMPLE**
***) Achtung: Musterteile-Nr. nur für B-Muster gültig**

WITH STANDARD SEAL (VMQ) Mit Standard-Dichtung (VMQ)	CODE I	CODE II	CODE III	CODE IV
COLOR OF SECONDARY LOCKING Farbe der Sekundärverriegelung	BLUE blau	GREY grau	GREEN grün	NATURE natur
SAMPLE NO. / Muster-Nr. *)	1 928 D01 686-02	1 928 D01 804-01	1 928 D01 806-01	
ORDER NO. / Bestell-Nr.	1 928 405 521	1 928 405 527	1 928 405 529	

WITH SPECIAL SEAL (F-VMQ) Mit Sonder-Dichtung (F-VMQ)	CODE I	CODE II	CODE III	CODE IV
COLOR OF SECONDARY LOCKING Farbe der Sekundärverriegelung	BLUE blau	GREY grau	GREEN grün	NATURE natur
ORDER NO. / Bestell-Nr.	1 928 405 986			

Weitere Informationen zur Steckverbindung: siehe Seite 11 - 17
FURTHER INFORMATIONS TO THE PLUG CONNECTION: SEE PAGE 11 - 17

© Alle Rechte bei ROBERT BOSCH GMBH, auch für den Fall von Schutzrechtsanmeldungen. Jede Verfügungs-befugnis, wie Kopier- und Weitergaberecht, bei uns

OFFER DRAWING Angebotszeichnung

13	REVISED	Fm	13.07.2016	Ka		NO. / Nr. 1 928 A00 517	en/de	SHEET /
NO.	MODIFICATION	SIGN	VALID	CHE.				Blatt 4
Nr.	Änderung	gez	gültig	gepr.				SH./ 17

**KOMPAKT 4 2 WAY
WITHOUT CPA
SECONDARY LOCKING OPEN**

**Kompakt 4 2polig
ohne CPA
Sekundärverriegelung offen**

© THIS DRAWING IS THE EXCLUSIVE PROPERTY OF ROBERT BOSCH GMBH. WITHOUT THEIR CONSENT IT MAY NOT BE REPRODUCED OR GIVEN TO THIRD PARTIES.

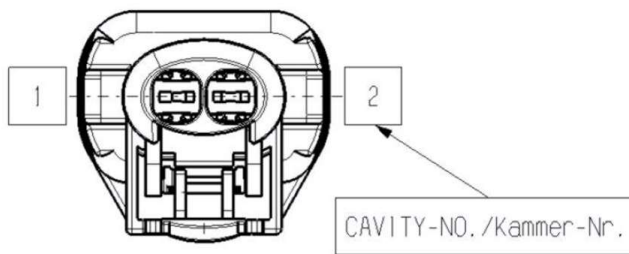
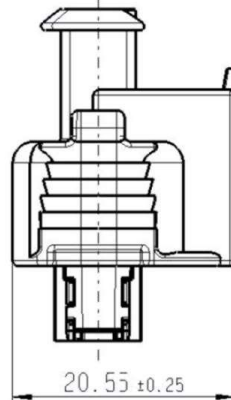
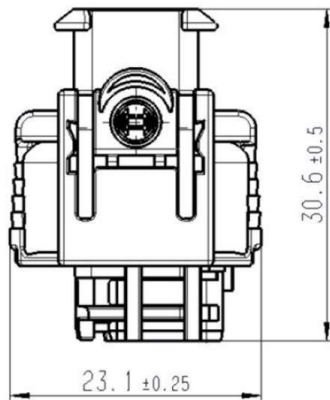
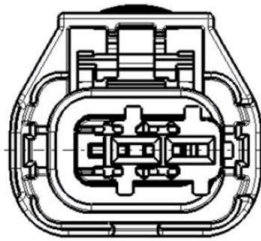

CODE I

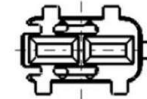

CODE II

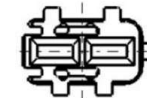

CODE III

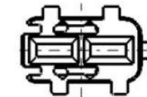

CODE IV

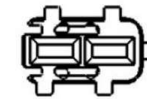

***) ATTENTION: SAMPLE PARTS NO. ONLY VALID FOR B-SAMPLE**
***) Achtung: Musterteile-Nr. nur für B-Muster gültig**

WITH STANDARD SEAL (VMQ) Mit Standard-Dichtung (VMQ)	CODE I	CODE II	CODE III	CODE IV
COLOR OF SECONDARY LOCKING Farbe der Sekundärverriegelung	BLUE blau	GREY grau	GREEN grün	NATURE natur
SAMPLE NO. / Muster-Nr. *)	1 928 D01 689-02	1 928 D01 900-01	1 928 D01 902-01	
ORDER NO. / Bestell-Nr.	1 928 405 522	1 928 405 530	1 928 405 532	

Weitere Informationen zur Steckverbindung: siehe Seite 11 - 17
FURTHER INFORMATIONS TO THE PLUG CONNECTION: SEE PAGE 11 - 17

© Alle Rechte bei ROBERT BOSCH GMBH, auch für den Fall von Schutzrechtsanmeldungen. Jede Verfügungsbefugnis, wie Kopier- und Weitergaberecht, bei uns

					OFFER DRAWING		Angebotszeichnung	
13	REVISED	Fm	13.07.2016	Ka		NO. / Nr.	en/de	SHEET /
NO.	MODIFICATION	SIGN	VALID	CHE.		1 928 A00 517		Blatt 5
Nr.	Änderung	gez	gültig	gepr.				SH./ 17