

SYMBOL DEFINITION		MISSING NUMBERS		DWO STATUS		REVISION HISTORY		AUTH	OR	APPROVAL
DATE	BY	REV	NO	DATE	REV	NO	ZONE			
12MPO2	R	01	-	15433700	-	RELEASED		222227	LE6	RE610MC
23M105	R	02	-	12052647	-	RESTRICTED AND REPLACED BY 12162000		268263	RTV	JAW/BOG
13AN05	R	03	-	12052647	-	NON-PHYSICAL REVISION LEVEL DB KAS D1		268863	PH	BOG

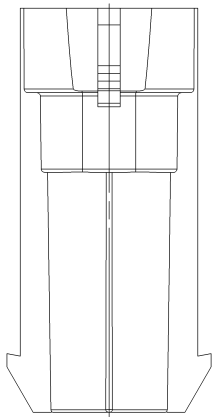

- NOTES
- UNLESS OTHERWISE SPECIFIED AND/OR INDICATED: DIMENSIONS ARE TO FACE OF VIEW SHOWN AND AUTOMATICALLY ROUNDED BY COMPUTER FOR INSPECTION. (SEE MATH MODEL FOR PRECISE DIMENSIONS.) FOR ALL OTHER DIMENSIONS NOT SHOWN BUT REQUIRED FOR TOOL BUILD, SEE MATH MODEL FOR PRECISE TOOL PATH DATA.
 - REFERENCE MATING COMPONENTS OR EQUIVALENT: CONNECTOR AND SEAL ASSEMBLY 12052641
 - THIS PART ACCEPTS THE FOLLOWING COMPONENTS OR EQUIVALENT: SECONDARY TERMINAL LOCK 12052634 TERMINAL 12045773 MAX. CABLE O.D. 2.8 MM CABLE SEAL 12048086
 - MATERIAL RECYCLING CODE PER ISO 11469. 12.31X10.11 RAISED CHARACTERS AS SHOWN TO BE LOCATED ON ANY EXTERIOR SURFACE. OPTIONAL CONSTRUCTION TO BE NO MATERIAL RECYCLING CODE.
 - 12.31X10.11 RAISED DELPHI CORPORATE BRAND TO BE LOCATED ON ANY EXTERIOR SURFACE, PREFERABLY VISIBLE AT FINAL ASSEMBLY. OPTIONAL CONSTRUCTION TO BE "PED" OR NO LOGO.

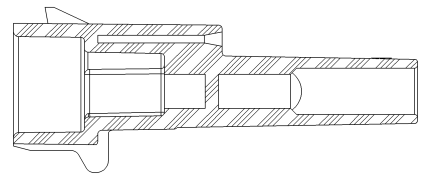
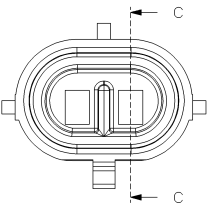
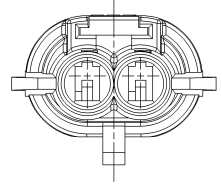
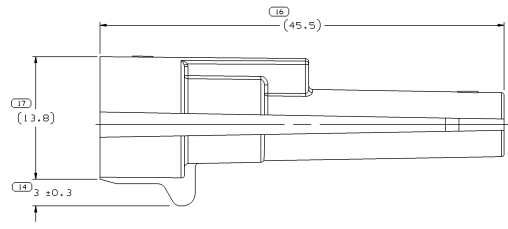
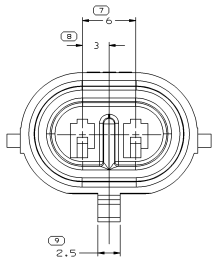
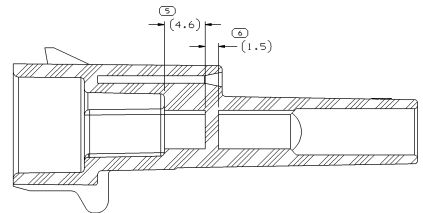
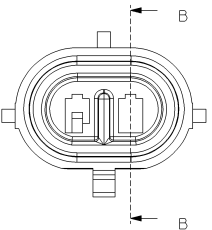
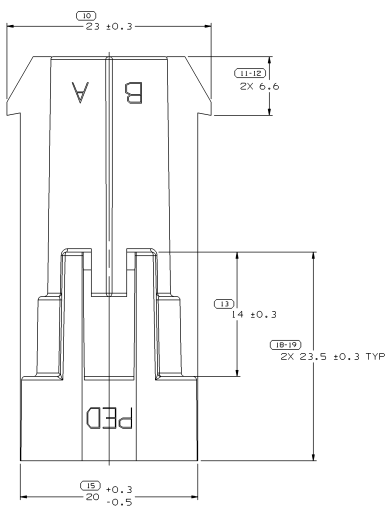
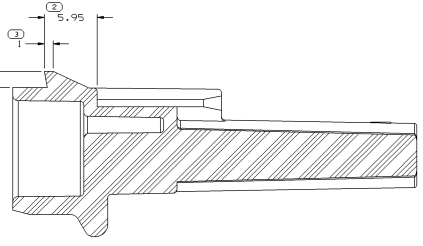
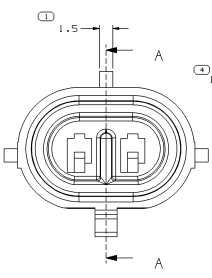
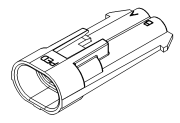

VIEW SCALE DOES NOT REFLECT ACTUAL PART SIZE

PART NO	REV N/P	STATUS	TYPE	MATERIAL SPECIFICATION AND COLOR	VOL CM ³	BLOCKED CAVITIES	REPLACED BY
15433700	01	-	104	M3592012 PA66 HS IM GRA LT	3.592	A,B	-
12162689	A	-	103	M3592001 PA66 HS IM BLK	3.755	B	-
12162000	A	-	102	M3592001 PA66 HS IM BLK	3.572	NONE	-
12052647	DB	-	101	M3592001 PA66 HS IM BLK	3.568	NONE	12162000

DWO TYPE		PART DRAWING	
FILE		DATE	
SCALE	1:1	REV	01
VIEW	FRONT	PROJ	1ST
REF	SEE CHART	PROJ	1ST
REF	SEE CHART	PROJ	1ST

DELPHI
DELPHI PACKAGED ELECTRIC SYSTEMS
WARREN, MI

DATE: 280604
280504
27FE95

SUBMITTERS OF CONCERN AND RECYCLED CONTENT PER DELPHI A 029000

DRAWING NUMBER: TAXI CONN M/M/P 150 SLD

DRAWING NUMBER: 12162690

SCALE: 5:1

SHEET NO: 1 OF 2

REV: R 03

1:5	PRECISE DIMENSIVE DIMENSION
1:10	EMERGENCY ENCLOSED IN () 3 DIGIT
1:20	EMERGENCY ENCLOSED IN () 4 DIGIT
1:50	EMERGENCY ENCLOSED IN () 5 DIGIT
1:100	EMERGENCY ENCLOSED IN () 6 DIGIT
1:200	EMERGENCY ENCLOSED IN () 7 DIGIT
1:500	EMERGENCY ENCLOSED IN () 8 DIGIT
1:1000	EMERGENCY ENCLOSED IN () 9 DIGIT
1:2000	EMERGENCY ENCLOSED IN () 0 DIGIT
1:5000	EMERGENCY ENCLOSED IN () 1 DIGIT
1:10000	EMERGENCY ENCLOSED IN () 2 DIGIT
1:20000	EMERGENCY ENCLOSED IN () 3 DIGIT
1:50000	EMERGENCY ENCLOSED IN () 4 DIGIT
1:100000	EMERGENCY ENCLOSED IN () 5 DIGIT
1:200000	EMERGENCY ENCLOSED IN () 6 DIGIT
1:500000	EMERGENCY ENCLOSED IN () 7 DIGIT
1:1000000	EMERGENCY ENCLOSED IN () 8 DIGIT
1:2000000	EMERGENCY ENCLOSED IN () 9 DIGIT