

# TS SEALED SERIES for STANDARD

## 0.64mm (025)

Structure / Detecting structure for incomplete terminal insertion.

B-02

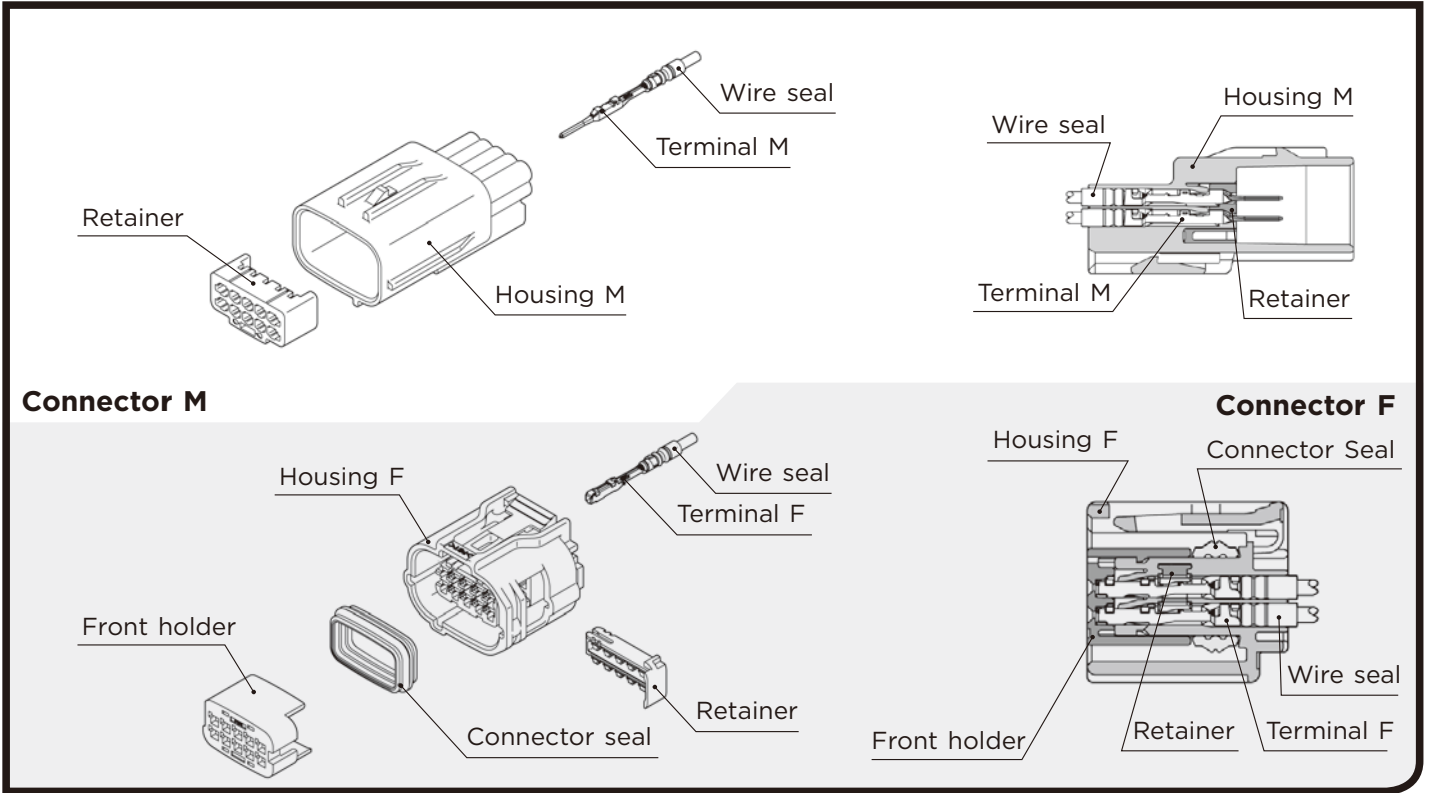

### 0.64mm (025)

(E)	(J)
Cable size	: 適用電線サイズ
Cable overall diameter	: 電線仕上り外径
Heat-resistant copper alloy	: 耐熱銅合金
Brass	: 黄銅
Surface treatment	: 表面処理
Gold-plated	: Auメッキ
Tin-plated	: Snメッキ

**Terminal** (UNIT : mm)

**(S)** **F (8240-0336)**

<b>Cable size (mm<sup>2</sup>)</b>	0.13
<b>Material</b>	Heat-resistant copper alloy
<b>Surface treatment</b>	Tin-plated

**(S)** **F (8240-0337)** **Au**

<b>Cable size (mm<sup>2</sup>)</b>	0.13
<b>Material</b>	Heat-resistant copper alloy
<b>Surface treatment</b>	Gold-plated

**(M)**

<b>Cable size (mm<sup>2</sup>)</b>	0.22~0.5
<b>Material</b>	Brass
<b>Surface treatment</b>	Tin-plated

**M (8100-3617)** **F (8100-3455)**

<b>Cable size (mm<sup>2</sup>)</b>	0.22~0.35
<b>Material</b>	Heat-resistant copper alloy
<b>Surface treatment</b>	Tin-plated

**(M)** **F (8240-0699)**

<b>Cable size (mm<sup>2</sup>)</b>	0.22~0.35
<b>Material</b>	Heat-resistant copper alloy
<b>Surface treatment</b>	Tin-plated

Note: Please contact to our sales staff for detail.  
詳細は、弊社営業担当にお問い合わせ下さい。

**(M)** **Au**

<b>Cable size (mm<sup>2</sup>)</b>	0.22~0.5
<b>Material</b>	Brass
<b>Surface treatment</b>	Gold-plated

**M (8100-3708)** **F (8100-3456)**

<b>Cable size (mm<sup>2</sup>)</b>	0.22~0.35
<b>Material</b>	Heat-resistant copper alloy
<b>Surface treatment</b>	Gold-plated

**(L)** **F (8240-0287)**

<b>Cable size (mm<sup>2</sup>)</b>	0.5
<b>Material</b>	Heat-resistant copper alloy
<b>Surface treatment</b>	Tin-plated

**(L)** **F (8240-0663)**

<b>Cable size (mm<sup>2</sup>)</b>	0.5
<b>Material</b>	Heat-resistant copper alloy
<b>Surface treatment</b>	Tin-plated

Note: Please contact to our sales staff for detail.  
詳細は、弊社営業担当にお問い合わせ下さい。

**(L)** **F (8240-0288)** **Au**

<b>Cable size (mm<sup>2</sup>)</b>	0.5
<b>Material</b>	Heat-resistant copper alloy
<b>Surface treatment</b>	Gold-plated

# 0.64mm (O25)

B-04

## Wire seals (UNIT : mm)

- Male / Female Shared
- M、F 共用です。

### (3S)

(7165-1423)

Cable size (mm <sup>2</sup> )	(CHFUS/0.13)
Cable overall diameter (mm)	0.85~0.95
Material	Silicone
Color	Light Brown

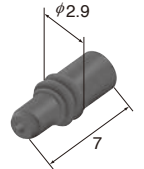

### (S)

(7165-1312)

Cable size (mm <sup>2</sup> )	(CHFUS/0.35~0.5)
Cable overall diameter (mm)	1.1~1.4
Material	Silicone
Color	Violet

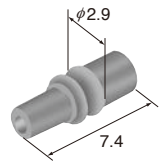

### (SS)

(7165-1043)

Cable size (mm <sup>2</sup> )	(CHFUS/0.22)
Cable overall diameter (mm)	0.95~1.05
Material	Silicone
Color	Green

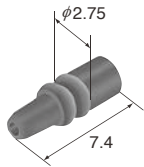

### (M)

(7165-1198)

Cable size (mm <sup>2</sup> )	(AVSS/0.3) (AVSSH/0.3) (AESSX/0.3)
Cable overall diameter (mm)	1.4~1.5
Material	Silicone
Color	Dark Yellow

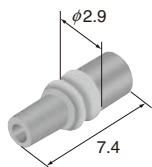

### (M)

(7165-0796)

Cable size (mm <sup>2</sup> )	(AVSS/0.3) (AVSSH/0.3) (AVSSX/0.3)
Cable overall diameter (mm)	1.4~1.5
Material	Silicone
Color	Reddish Brown

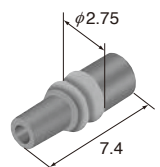

### (M)

(7165-0891)

Cable size (mm <sup>2</sup> )	(AESSX/0.3)
Cable overall diameter (mm)	1.4~1.5
Material	Silicone
Color	Dark Brown

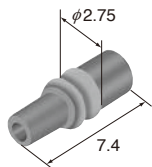

### (L)

(7165-1199)

Cable size (mm <sup>2</sup> )	(AVSS/0.5) (AVSSH/0.5) (AVSSX/0.5) (AESSX/0.5)
Cable overall diameter (mm)	1.6~1.7
Material	Silicone
Color	Red Violet

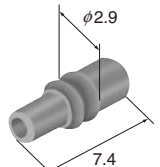

### (L)

(7165-0815)

Cable size (mm <sup>2</sup> )	(AVSS/0.5) (AVSSH/0.5) (AVSSX/0.5)
Cable overall diameter (mm)	1.6~1.7
Material	Silicone
Color	Dark Gray

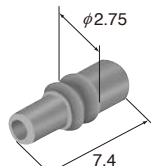

## 0.64mm (025)

### Dummy plugs (UNIT : mm)

- Male / Female Shared
- Dummy plugs are used to blind unused terminal holes.
- M、F 共用です。
- 不必要なターミナル穴を塞ぐために、ダミー栓を使用します。

(7165-0797)

Material NBR  
Color Light Gray

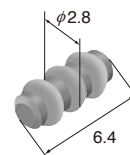

## 0.64mm (025)

### Housing (UNIT : mm)

Ref: Terminal part No. B-02  
Ref: wire seal No. B-04  
Ref: Dummy plug No. B-05  
Material PBT

### 2way

Color Black

Note: with clip for oval hole

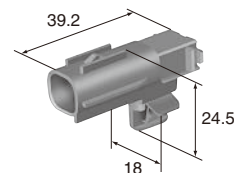

M (6188-4797)

F (6189-1161)

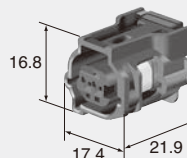

Color Black

### 2way

F (6189-8080)

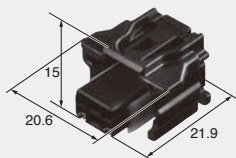

Color Black

### 2way

F (6189-7246)

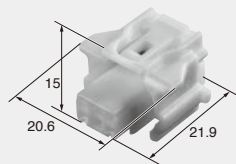

Color Natural

### 2way

F (6189-7020)

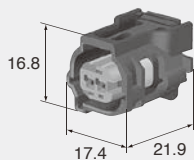

Color Black

### 2way

F (6189-7073)

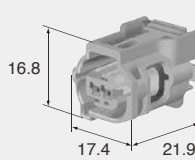

Color Gray

**3way**

**Color** Black

Note: Bracket size 9mm

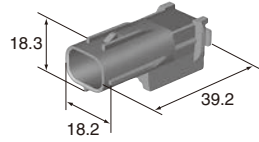

**B-06**

**M (6188-4920)**

**F (6189-1129)**

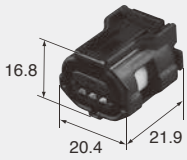

**Color** Black

**3way**

**F (6189-1132)**

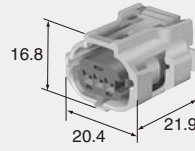

**Color** Gray

**4way**

**F (6189-6946)**

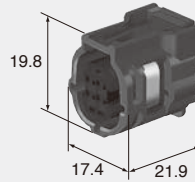

**Color** Black

**4way**

**F (6189-7401)**

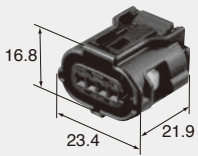

**Color** Black

**5way**

**F (6189-1046)**

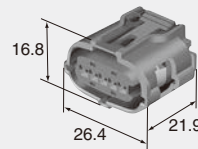

**Color** Black

**6way**

**Color** Natural

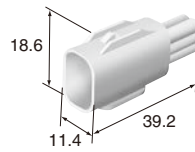

**M (6188-0706)**

**F (6189-1142)**

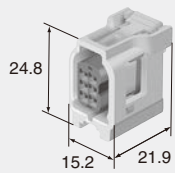

**Color** Natural

**6way**

**Color** Black

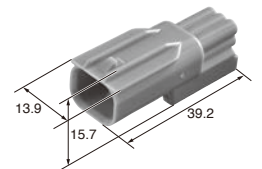

**M (6188-5405)**

**F (6189-8094)**

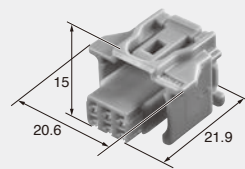

**Color** Black

**6way**

Color Black

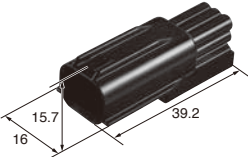

**M (6188-5970)** **F (6189-7334)**

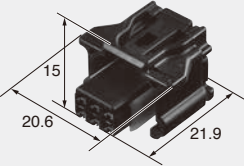

Color Black

**8way**

Color Gray

Note: Bracket size 9mm

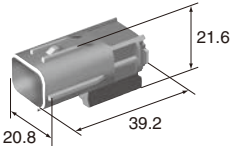

**M (6188-0779)** **F (6189-1240)**

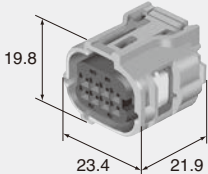

Color Gray

**12way**

**F (6189-1128)**

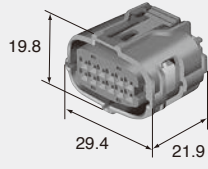

Color Black

**12way**

**F (6189-1133)**

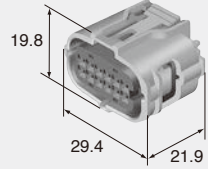

Color Gray

**6way**

**F (6189-1083)**

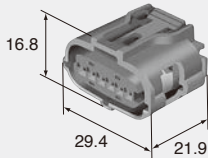

Color Black

**6way**

**F (6189-7100)**

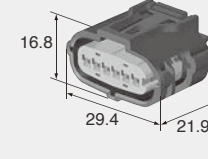

Color Black

**10way**

Color Black

Note: Bracket size 9mm

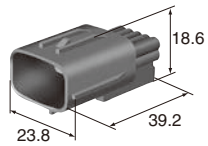

**M (6188-0696)** **F (6189-1134)**

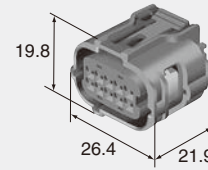

Color Black

**13way**

Color Gray

Note: Bracket size 13mm

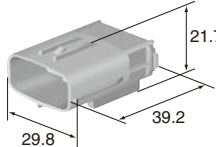

**M (6188-4914)** **F (6189-1092)**

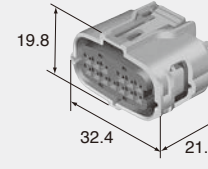

Color Gray

**14way**

**F (6189-7536)**

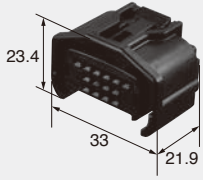

Color                      Black

**15way**

**F (6189-1135)**

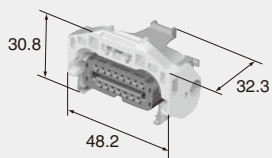

Color                      Gray

**17way**

**F (6189-7110)**

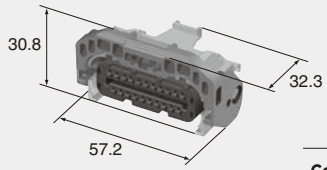

Color                      Gray

**20way**

**F (6189-7167)**

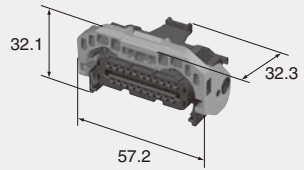

Color                      Black

**30way**

**F (6189-6987)**

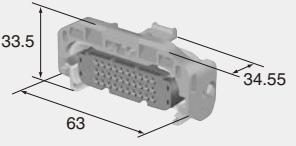

Color                      Gray