

# HX SEALED SERIES for STANDARD

## 1.5mm (060)

### Structure

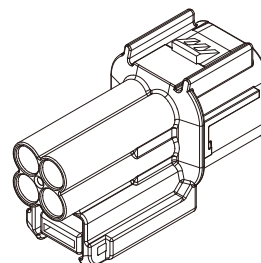
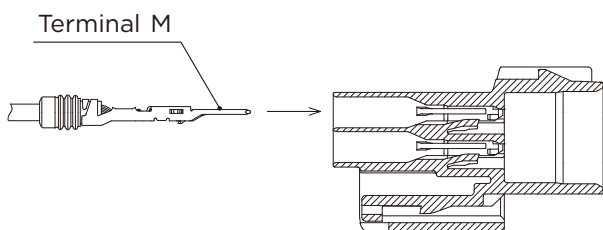

Housing M

Housing F

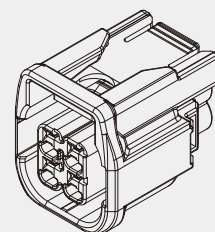
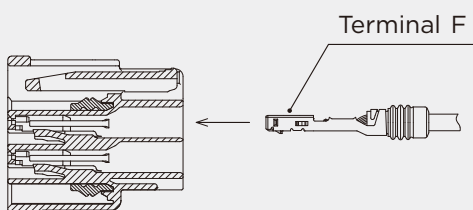

E-13

HX SEALED SERIES

## 1.5mm (060)

(E)	(J)
Cable size	: 適用電線サイズ
Cable overall diameter	: 電線仕上り外径
Heat-resistant copper alloy	: 耐熱銅合金
Brass	: 黄銅
Surface treatment	: 表面処理
Gold-plated	: Auメッキ
Tin-plated	: Snメッキ

## Terminal (UNIT : mm)

**(SS)**Cable size (mm<sup>2</sup>) 0.13~0.22

Material Brass

Surface treatment Tin-plated

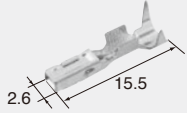
**M (8230-5306)****F (8240-0489)**Cable size (mm<sup>2</sup>) 0.13~0.22

Material Heat-resistant copper alloy

Surface treatment Tin-plated

**(S)**Cable size (mm<sup>2</sup>) 0.3~0.5

Material Brass

Surface treatment Tin-plated

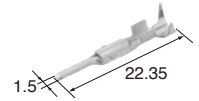
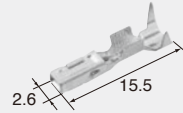
**M (8230-5307)****F (8240-0490)**Cable size (mm<sup>2</sup>) 0.3~0.5

Material Heat-resistant copper alloy

Surface treatment Tin-plated

**(M)**Cable size (mm<sup>2</sup>) 0.75~1.25

Material Brass

Surface treatment Tin-plate

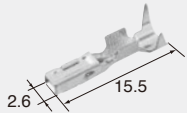
**M (8230-5308)****F (8240-0491)**Cable size (mm<sup>2</sup>) 0.75~1.25

Material Heat-resistant copper alloy

Surface treatment Tin-plated

**(L)**Cable size (mm<sup>2</sup>) 2.0

Material Brass

Surface treatment Tin-plated

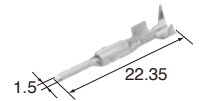
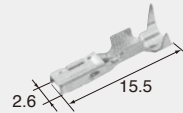
**M (8230-5309)****F (8240-0492)**Cable size (mm<sup>2</sup>) 2.0

Material Heat-resistant copper alloy

Surface treatment Tin-plated

**1.5mm (O60)****Wire seals (UNIT : mm)**

The wire seals are common to M and F.

ワイヤシールは、M、F 共用です。

**(SS)****(7165-1562)**

Cable overall diameter (mm) 0.85~1.2

Material Silicone

Color Violet

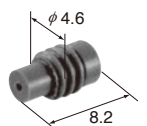

**(S)****(7165-1563)**

Cable overall diameter(mm) 1.05~1.5

Material Silicone

Color Sky Blue

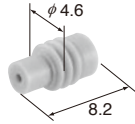
**(M)****(7165-1564)**

Cable overall diameter(mm) 1.35~1.9

Material Silicone

Color Light Green

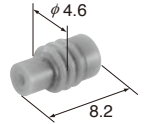
**(L)****(7165-1565)**

Cable overall diameter(mm) 1.75~2.4

Material Silicone

Color Blue

**(LL)****(7165-1566)**

Cable overall diameter(mm) 2.4~3

Material Silicone

Color Dark Yellow

**E-15**

HX SEALED SERIES

## 1.5mm (060)

### Dummy plugs (UNIT : mm)

Ref; 1.5mm Dummy plug detail

**(7165-0193)** J-07

- Dummy plugs are common to M and F.
- Dummy plugs are used to blind unused terminal holes.
- ダミー栓はM、F 共用です。
- 不必要なターミナル穴を塞ぐために、ダミー栓を使用します。

## 1.5mm (060)

### Housing (UNIT : mm)

Ref: Terminal part No. E-13

Ref: wire seal No. E-14

Ref: Dummy plug No. J-07

Material PBT

### 2way

Color Black

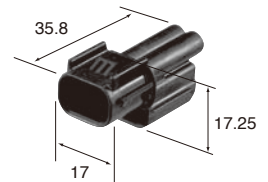
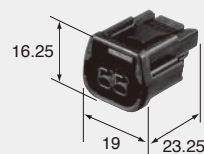
**M (6181-6851)****F (6189-7408)**

Color Black

**3way**

**F (6189-7494)**

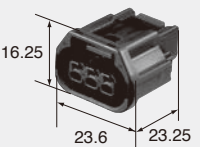

Color Black

**4way**

Color Black

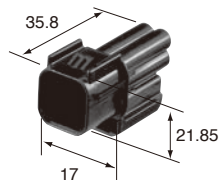

**M (6181-6783)**

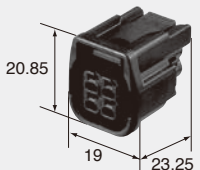

Color Black

**F (6189-7409)**

**8way**

Color Black

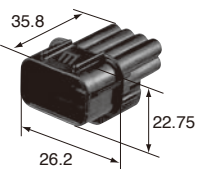

**M (6181-6850)**

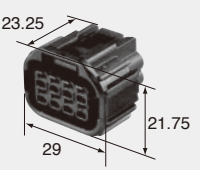

Color Black

**F (6189-7423)**

**12way**

Color Black

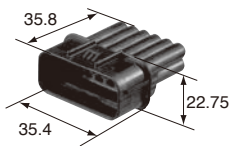

**M (6181-6784)**

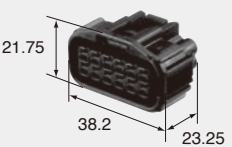

Color Black

**F (6189-7410)**