

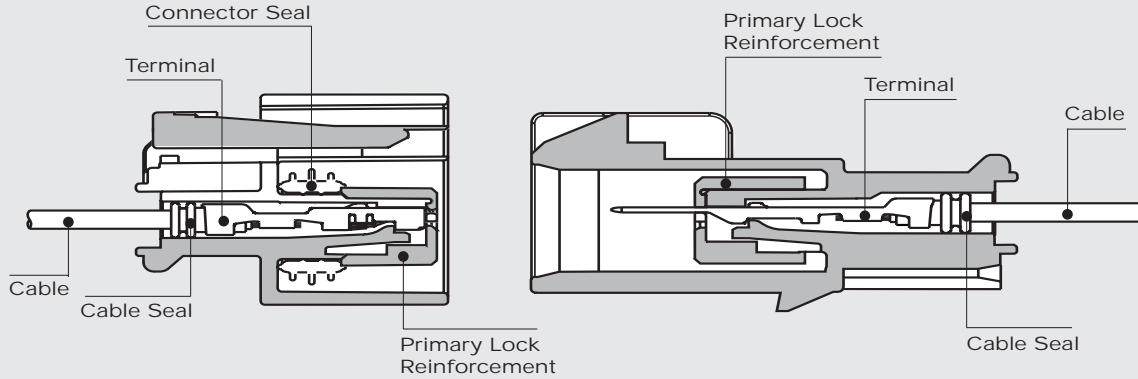

280

Cross Sectional View



Female Connector Assembly

Male Connector Assembly

GT 280 Female Terminals Sealed			
Part #	Cable Range (mm ²)	Material	Plating
15304718	0.50-0.35	Tin Brass	Tin
15304719	1.00-0.75	Tin Brass	Tin
15304720†	3.00-1.50	Tin Brass	Tin
15326004	5.00-4.00	Beryllium Copper	Tin

GT 280 Cable Seals				
Reel Part #	Loose Part #	Cable Diameter	Material	Color
12191221	15366065	1.20-1.85	Silicone	Orange
12191222	15366066	1.86-2.25	Silicone	Yellow
12191223	15366067	2.50-3.20	Silicone	Tan
-	15336674†	2.70-3.20	Silicone	Blue
-	12191235	3.40-3.90	Silicone	Purple

GT 280 Female Connector Assemblies Sealed USCAR Footprint			
USCAR #	Delphi Part #	Color	Material
280-S-002-1-A01	13517352	Black	PBT 20% GF
280-S-006-2-A01	15476196	Black	PBT 20% GF
280-S-006-2-B01	15476197	Grey	PBT 20% GF
280-S-006-2-C01	15476198	Brown	PBT 20% GF
280-S-006-2-D01	15476199	Green	PBT 20% GF

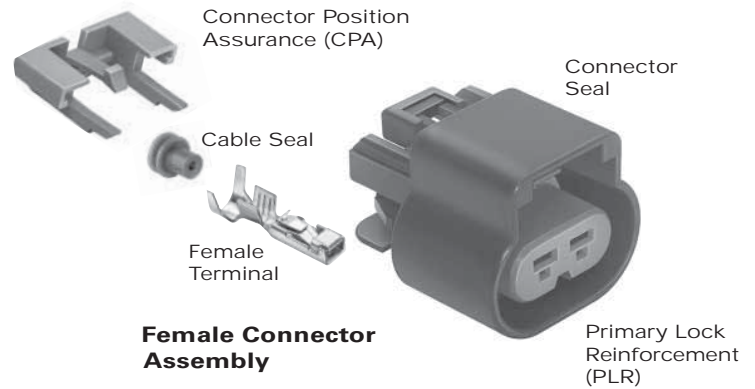

Female Connector Assembly

GT 280 Female Connector Assemblies Sealed			
# Cavities	Conn. Asm.	Color	Material
2	13518845	Black	PBT 20% GF
3	13521455	Black	PBT 20% GF
4	13521459	Black	PBT 20% GF
5	13521463	Black	PBT 20% GF
6	13521467	Black	PBT 20% GF
8	15326654	Black	PA6 10% GF & 20% GB
10	15326660	Black	PA6 10% GF & 20% GB
12	15326910	Black	PA6 10% GF & 20% GB
14	15326917	Black	PA6 10% GF & 20% GB
16	15326666	Black	PA6 10% GF & 20% GB

Primary Lock Reinforcement (PLR) and Connector Seals are included in the Connector Assemblies listed in this section.

† Note: If cable seal 15336674 is used with terminal 15304720, connector cavity needs to be designed with 5.2mm diameter sealing surface.

NOTE: Specifications in this catalog are for general reference only and are subject to change without notice. To verify product information, please contact a Delphi representative.



280

Sealed System Application Information

280 Series Terminals – Tin Plated

- CABLE RANGE (mm²): 0.35-5.0
- CURRENT RANGE (AMPS): 0-25
- TEMP RANGE °C: -40 to 125
- RESISTANCE: <10mΩ@20mV
- VOLTAGE DROP: <4.0mV/amp
- CENTERLINE SPACING (mm): 6.5
- BLADE WIDTH (mm): 2.8

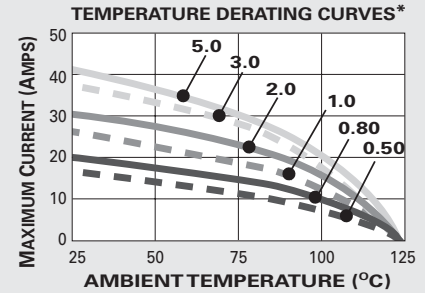
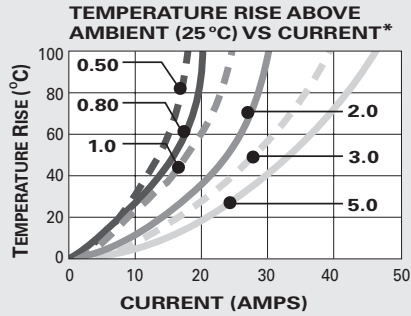

*The test data are based on single circuits in free space and were generated using a "Lumped Resistance" model. This model does not account for all of the variables that would be present in an actual application. For actual product performance, contact your regional support representative.

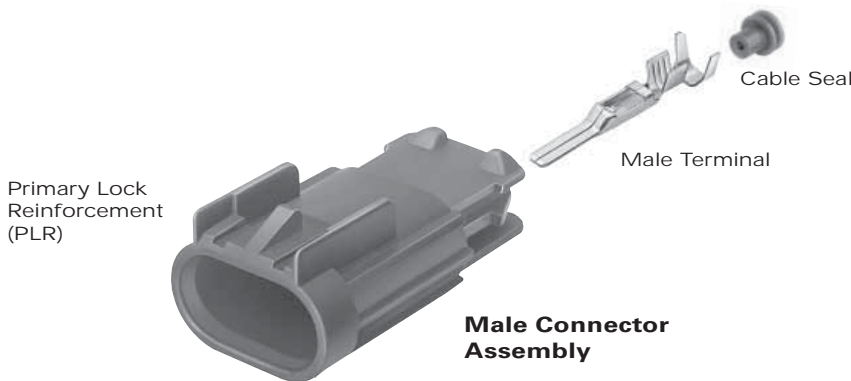

GT 280 Male Connector Assemblies Sealed			
# Cavities	Connector	Color	Material
2	13518847	Black	PBT 20% GF
3	13521457	Black	PBT 20% GF
4	13521461	Black	PBT 20% GF
5	13521465	Black	PBT 20% GF
6	13521469	Black	PBT 20% GF
8	15326655	Black	PA6 10% GF & 20% GB
10	15326661	Black	PA6 10% GF & 20% GB
12	15326915	Black	PA6 10% GF & 20% GB
14	15326922	Black	PA6 10% GF & 20% GB
16	15326667	Black	PA6 10% GF & 20% GB

Primary Lock Reinforcement is included in the Connector Assemblies listed in this section.

GT 280 Male Terminals Sealed			
Part #	Cable Range (mm ²)	Material	Plating
15304730	0.50-0.35	Tin Brass	Tin
15304731	1.00-0.75	Tin Brass	Tin
15304732	3.00-1.50	Tin Brass	Tin

GT 280 Cavity Plug*			
Part #	Cavity Diameter	Material	Color
15305170	5.8mm	Silicone	White

* Cavity plugs seal unused female and male cavities.

SECTION NOTES:

- Due to rigid tolerances of connector cavities, it is critical to meet all crimp dimensions as specified.

NOTE: Specifications in this catalog are for general reference only and are subject to change without notice. To verify product information, please contact a Delphi representative.



280

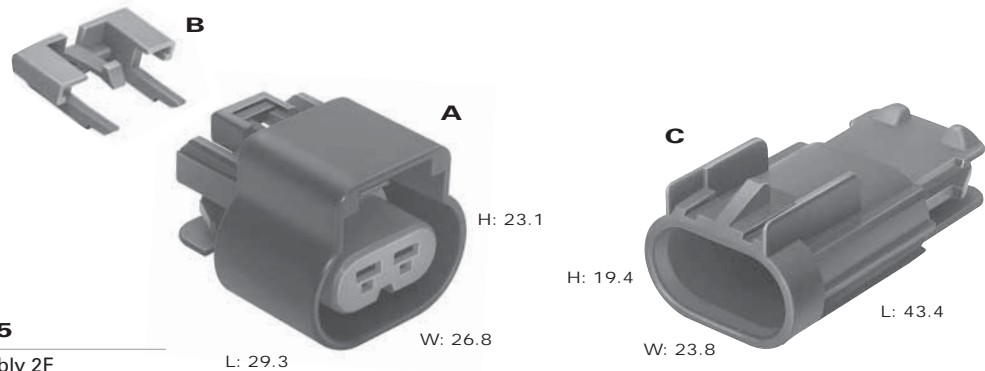

Total Mated Length: 56.7mm

A. Part No: 13518845

Description: Connector Assembly 2F
 Size: 29.3L x 23.1H x 26.8W
 Color: Black
 Material: PBT 20% GF
 Terminals: See Page 1.18
 Seals/Plugs: See Page 1.18, 1.19

Part No: 13521455

Description: Connector Assembly 3F
 Size: 29.3L x 23.1H x 33.3W
 Color: Black
 Material: PBT 20% GF
 Terminals: See Page 1.18
 Seals/Plugs: See Page 1.18, 1.19

Part No: 13521459

Description: Connector Assembly 4F
 Size: 29.3L x 23.1H x 39.8W
 Color: Black
 Material: PBT 20% GF
 Terminals: See Page 1.18
 Seals/Plugs: See Page 1.18, 1.19

Part No: 13521463

Description: Connector Assembly 5F
 Size: 29.3L x 23.1H x 46.3W
 Color: Black
 Material: PBT 20% GF
 Terminals: See Page 1.18
 Seals/Plugs: See Page 1.18, 1.19

Part No: 13521467

Description: Connector Assembly 6F
 Size: 29.3L x 23.1H x 52.8W
 Color: Black
 Material: PBT 20% GF
 Terminals: See Page 1.18
 Seals/Plugs: See Page 1.18, 1.19

B. Part No: 15317832

Description: CPA
 Color: Gray
 Material: PA6 10% GF & 20% GB

C. Part No: 13518847

Description: Connector Assembly 2M
 Size: 43.4L x 19.4H x 23.8W
 Color: Black
 Material: PBT 20% GF
 Terminals: See Page 1.19
 Seals/Plugs: See Page 1.18, 1.19

Part No: 13521457

Description: Connector Assembly 3M
 Size: 43.4L x 19.4H x 30.3W
 Color: Black
 Material: PBT 20% GF
 Terminals: See Page 1.19
 Seals/Plugs: See Page 1.18, 1.19

Part No: 13521461

Description: Connector Assembly 4M
 Size: 43.4L x 19.4H x 36.8W
 Color: Black
 Material: PBT 20% GF
 Terminals: See Page 1.19
 Seals/Plugs: See Page 1.18, 1.19

Part No: 13521465

Description: Connector Assembly 5M
 Size: 43.4L x 19.4H x 43.3W
 Color: Black
 Material: PBT 20% GF
 Terminals: See Page 1.19
 Seals/Plugs: See Page 1.18, 1.19

Part No: 13521469

Description: Connector Assembly 6M
 Size: 43.4L x 19.4H x 49.8W
 Color: Black
 Material: PBT 20% GF
 Terminals: See Page 1.19
 Seals/Plugs: See Page 1.18, 1.19

NOTE: Specifications in this catalog are for general reference only and are subject to change without notice. To verify product information, please contact a Delphi representative.

280

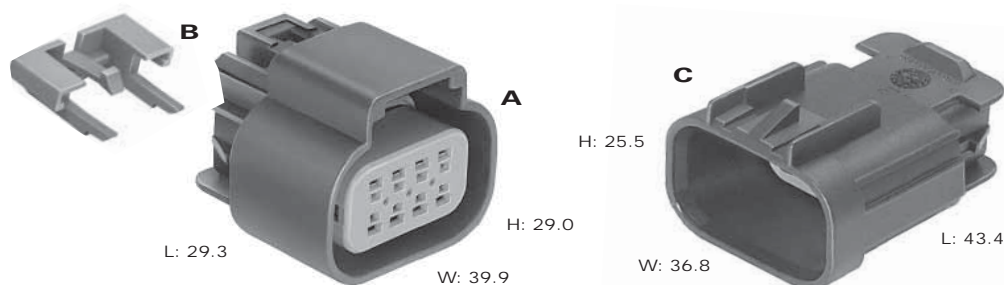
**A. Part No: 15326654**

Description:	Connector Assembly 8F
Size:	29.3L x 29.0H x 39.9W
Color:	Black
Material:	PA6 10% GF & 20% GB
Terminals:	See Page 1.18
Seals/Plugs:	See Page 1.18, 1.19

Part No: 15326660

Description:	Connector Assembly 10F
Size:	29.3L x 29.0H x 46.4W
Color:	Black
Material:	PA6 10% GF & 20% GB
Terminals:	See Page 1.18
Seals/Plugs:	See Page 1.18, 1.19

Part No: 15326910

Description:	Connector Assembly 12F
Size:	29.3L x 29.0H x 52.9W
Color:	Black
Material:	PA6 10% GF & 20% GB
Terminals:	See Page 1.18
Seals/Plugs:	See Page 1.18, 1.19

Part No: 15326917

Description:	Connector Assembly 14F
Size:	29.3L x 29.0H x 59.4W
Color:	Black
Material:	PA6 10% GF & 20% GB
Terminals:	See Page 1.18
Seals/Plugs:	See Page 1.18, 1.19

Part No: 15326666

Description:	Connector Assembly 16F
Size:	29.3L x 29.0H x 65.9W
Color:	Black
Material:	PA6 10% GF & 20% GB
Terminals:	See Page 1.18
Seals/Plugs:	See Page 1.18, 1.19

B. Part No: 15317832

Description:	CPA
Color:	Gray
Material:	PA6 10% GF & 20% GB

Total Mated Length: 56.7mm

C. Part No: 15326655

Description:	Connector Assembly 8M
Size:	43.4L x 25.5H x 36.8W
Color:	Black
Material:	PA6 10% GF & 20% GB
Terminals:	See Page 1.19
Seals/plugs:	See Page 1.18, 1.19

Part No: 15326661

Description:	Connector Assembly 10M
Size:	43.4L x 25.5H x 43.3W
Color:	Black
Material:	PA6 10% GF & 20% GB
Terminals:	See Page 1.19
Seals/Plugs:	See Page 1.18, 1.19

Part No: 15326915

Description:	Connector Assembly 12M
Size:	43.4L x 25.5H x 49.8W
Color:	Black
Material:	PA6 10% GF & 20% GB
Terminals:	See Page 1.19
Seals/Plugs:	See Page 1.18, 1.19

Part No: 15326922

Description:	Connector Assembly 14M
Size:	43.4L x 25.5H x 56.3W
Color:	Black
Material:	PA6 10% GF & 20% GB
Terminals:	See Page 1.19
Seals/Plugs:	See Page 1.18, 1.19

Part No: 15326667

Description:	Connector Assembly 16M
Size:	43.4L x 25.5H x 62.8W
Color:	Black
Material:	PA6 10% GF & 20% GB
Terminals:	See Page 1.19
Seals/Plugs:	See Page 1.18, 1.19

NOTE: Specifications in this catalog are for general reference only and are subject to change without notice. To verify product information, please contact a Delphi representative.



280 Device Connections

GT 280 Connection Systems are designed to mate to most headlamps, including a variety of daytime running lamps, high beam, and dual filament BULBS.

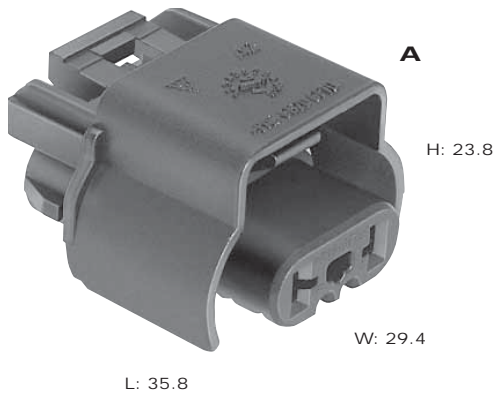

A. Part No: 15336116

Description:	Connector Assembly 2F
Size:	35.8L x 23.8H x 29.4W
Color:	Black
Material:	PA6 20% GF & 10% GB
Terminals:	See Page 1.18
Seals/Plugs:	See Page 2.30, 2.31

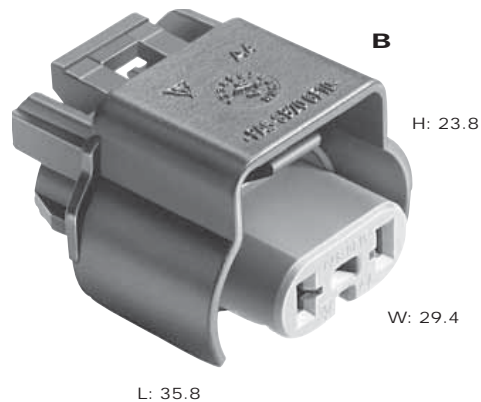

B. Part No: 15336117

Description:	Connector Assembly 2F
Size:	35.8L x 23.8H x 29.4W
Color:	Brown
Material:	PA6 20% GF & 10% GB
Terminals:	See Page 1.18
Seals/Plugs:	See Page 2.30, 2.31

NOTE: Specifications in this catalog are for general reference only and are subject to change without notice. To verify product information, please contact a Delphi representative.