

S タイプコネクタとは、Mターミナルタブ幅 2.8mm の非防水コネクタです。
 S TYPE CONNECTOR: THE BLADE WIDTH OF THE MALE TERMINAL FOR THIS CONNECTOR IS 0.110 INCHES./ UNSEALED CONNECTOR

[特 徴] [DISTINCTIVE FEATURES]

- ① リヤホルダの採用により、ターミナルを二重係止し端子抜けを防止します。
 - ② 慣性ロック方式によりコネクタの中途かん合をなくします。
1. DOUBLE TERMINAL LOCKING SYSTEM (HOUSING LANCE REAR HOLDER) ELIMINATES TERMINAL PUSH-OUT.
 2. STABLE/SECURE MATING ACTION BETWEEN MALE AND FEMALE CONNECTORS.

構造と名称 CONSTRUCTION

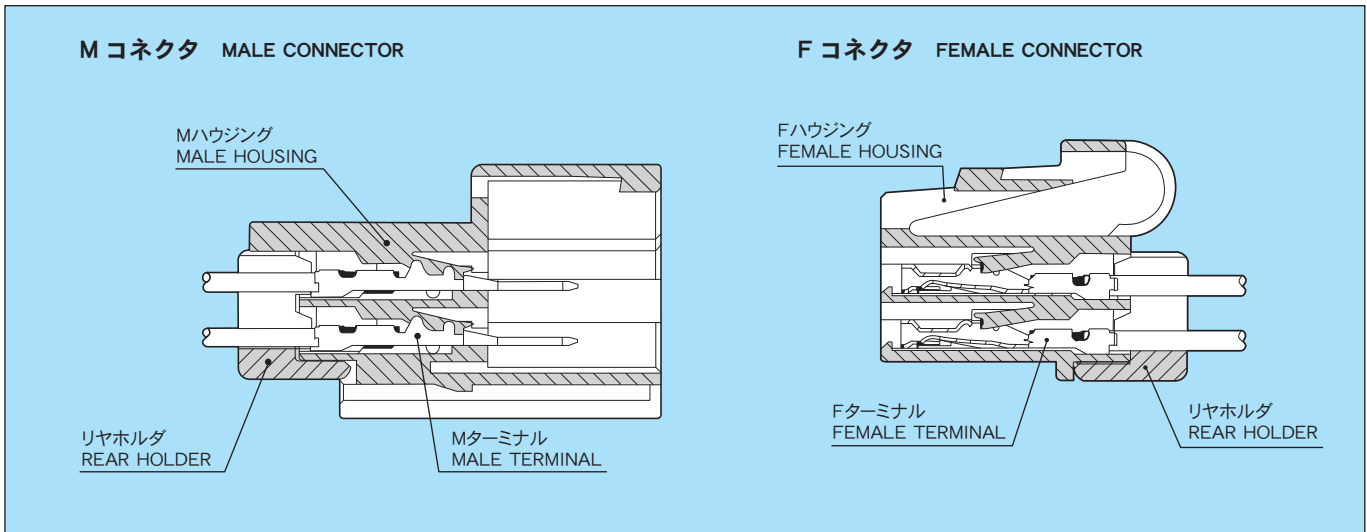

仕様 SPECIFICATIONS

材 質	ハウジング HOUSING	6 ナイロン、PBT NYLON6 AND PBT
	Mターミナル MALE TERMINAL	黄銅 (Sn メッキ)、〔銅合金 (Sn メッキ)〕、黄銅 (Au メッキ) BRASS(TIN PLATING), (COPPER ALLOY(TIN PLATING)), BRASS(GOLD PLATING)
	Fターミナル FEMALE TERMINAL	黄銅 (Sn メッキ)、〔本体:銅合金 (Sn メッキ) パネ部:銅合金 (Sn メッキ)〕、黄銅 (Au メッキ) BRASS(TIN PLATING), (BODY: COPPER ALLOY(TIN PLATING), SPRING:COPPER ALLOY(TIN PLATING)), BRASS(GOLD PLATING)
※許容電流 (参考値) ※CURRENT CAPACITY (REFERENCE)		10A
低電圧低電流抵抗 RESISTANCE AT LOW VOLTAGE		3mΩ 以下 (初期値) 3mΩ MAX. (INITIAL VALUE)
絶縁抵抗 INSULATION RESISTANCE		DC500V 100MΩ 以上 DC500V 100MΩ MIN.
耐電圧 DIELECTRIC STRENGTH		AC1000V (1 分間) AC1000V (1 min.)

※許容電流：使用極数・電線サイズ・通電時間及び使用温度により数値は異なります。
 ※ CURRENT CAPACITY WILL BE AFFECTED BY CONDITIONS SUCH AS POLE QUANTITY, WIRE SIZE, AMBIENT TEMPERATURE, ETC.

() 内はヘビー仕様
 HEAVY TYPE TERMINAL PART NUMBER IN PARENTHESIS.

部品品番一覧 PART NUMBER CHART

() 内はヘビー仕様 HEAVY TYPE TERMINAL PART NUMBER IN PARENTHESIS.

部品名称 PART NAME	M	F
ターミナル TERMINAL	7114-1230 [7114-1238]	7116-1230 [7116-1342]
	7114-1230-08	7116-1230-08
	7114-1231 [7114-1239]	7116-1231 [7116-1343]
	7114-1231-08	7116-1231-08

部品品番一覧 PART NUMBER CHART

部品名称 PART NAME	極数 POLES	M		F	
		ハウジング HOUSING	リヤホルダ REAR HOLDER	ハウジング HOUSING	リヤホルダ REAR HOLDER
ハウジング HOUSING	1	7122-1610	7157-6010-70	7123-1610	7157-6010-70
	1	7122-1619-90	7157-6010-90	7123-1619-90	7157-6010-90
	2	7122-1620	7157-6020-70	7123-1620	7157-6020-70
	2	7122-1629-90	7157-6022-90	7123-1629-90	7157-6023-90
	2	7122-1623-30	7157-6024	7123-1623-30	7157-6024
	3	7122-1630	7157-6030-70	7123-1630	7157-6030-70
	3	7122-1639-90	7157-6032-90	7123-1639-90	7157-6033-90
	4	7122-1640	7157-6040-70	7123-1640	7157-6040-70
	4	7122-1649-90	7157-6042-90	7123-1649-90	7157-6042-90
	6	7122-1660	7157-6060-70	7123-1660	7157-6060-70
	6	7122-1669-90	7157-6062-90	7123-1669-90	7157-6063-90
	8	7122-1680	7157-6080-70	7123-1680	7157-6080-70
	8	7122-1689-90	7157-6082-90	7123-1689-90	7157-6083-90
	8	7122-1683-30	7157-6084	7123-1683-30	7157-6085
	10	7122-1700	7157-6100-70	7123-1700	7157-6101-70
	10	7122-1709-90	7157-6102-90	7123-1709-90	7157-6103-90
12	7122-1729-90	7157-6122-90	7123-1729-90	7157-6123-90	
16	7122-1769-90	7157-6162-90	7123-1769-90	7157-6163-90	

ターミナル TERMINAL

単位：mm UNIT: mm

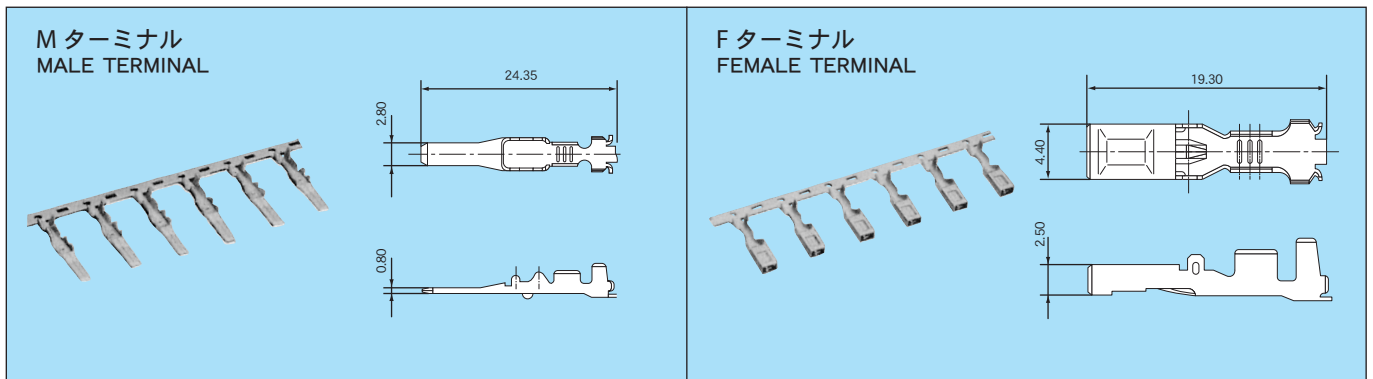

仕様 SPECIFICATIONS

部品名称 PART NAME	品番 PART NUMBER	材質 MATERIAL	表面処理 TREATMENT	板厚 (mm) MATERIAL THICKNESS
M ターミナル MALE TERMINAL	7114-1230	黄銅 BRASS	Snメッキ TIN PLATING	0.4
	7114-1230-08		Auメッキ GOLD PLATING	
	7114-1231		Snメッキ TIN PLATING	
	7114-1231-08		Auメッキ GOLD PLATING	
	7114-1238	銅合金 COPPER ALLOY	Snメッキ TIN PLATING	
	7114-1239		Snメッキ TIN PLATING	
F ターミナル FEMALE TERMINAL	7116-1230	黄銅 BRASS	Snメッキ TIN PLATING	0.3
	7116-1230-08		Auメッキ GOLD PLATING	
	7116-1231		Snメッキ TIN PLATING	
	7116-1231-08		Auメッキ GOLD PLATING	
	7116-1342	本体：銅合金 BODY: COPPER ALLOY バネ部品：銅合金 SPRING: COPPER ALLOY	Snメッキ TIN PLATING	
	7116-1343		Snメッキ TIN PLATING	

●適用電線一覧 APPLICABLE WIRE CHART

〔 〕内はヘビー仕様 HEAVY TYPE TERMINAL PART NUMBER IN PARENTHESIS.

部品名称 PART NAME	適用電線サイズ (mm ²) WIRE SIZE (mm ²)	電線品種 WIRE TYPE	端子品番 PART NUMBER (TERMINAL)
Mターミナル MALE TERMINAL	0.3	AVS	7114-1230 [7114-1238]
		CAVS	7114-1230
	0.5	AVS	7114-1230 [7114-1238]
		CAVS	7114-1230
	0.85	AVS	7114-1231 [7114-1239]
		CAVS	7114-1231
1.25	AVS	7114-1231 [7114-1239]	
	CAVS	7114-1231	
Fターミナル FEMALE TERMINAL	0.3	AVS	7116-1230 [7116-1342]
		CAVS	7116-1230
	0.5	AVS	7116-1230 [7116-1342]
		CAVS	7116-1230
	0.85	AVS	7116-1231 [7116-1343]
		CAVS	7116-1231
	1.25	AVS	7116-1231 [7116-1343]
		CAVS	7116-1231
	2	AVS	7116-1231 [7116-1343]

極数 POLES	M ハウジング MALE HOUSING	F ハウジング FEMALE HOUSING
1	<p>S01MW</p> <p>7122-1610 (7157-6010-70)</p>	<p>S01FW</p> <p>7123-1610 (7157-6010-70)</p>
1	<p>S01ML</p> <p>7122-1619-90 (7157-6010-90)</p>	<p>S01FL</p> <p>7123-1619-90 (7157-6010-90)</p>
2	<p>S02MW</p> <p>7122-1620 (7157-6020-70)</p>	<p>S02FW</p> <p>7123-1620 (7157-6020-70)</p>
2	<p>S02ML</p> <p>7122-1629-90 (7157-6022-90)</p>	<p>S02FL</p> <p>7123-1629-90 (7157-6023-90)</p>
2	<p>S02MB</p> <p>7122-1623-30 (7157-6024)</p>	<p>S02FB</p> <p>7123-1623-30 (7157-6024)</p>
3	<p>S03MW</p> <p>7122-1630 (7157-6030-70)</p>	<p>S03FW</p> <p>7123-1630 (7157-6030-70)</p>

()は、リヤホルダ品番 REAR HOLDER PART NUMBER IN PARENTHESIS.

ハウジング材質: 6 ナイロン HOUSING MATERIAL: NYLON6

単位: mm UNIT: mm

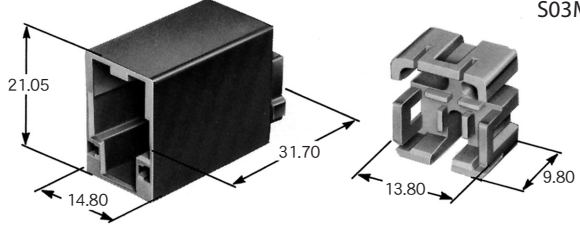
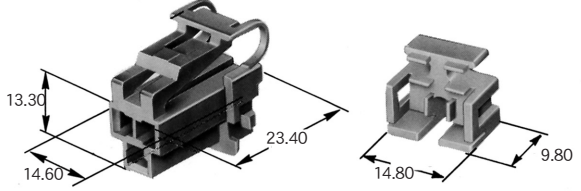
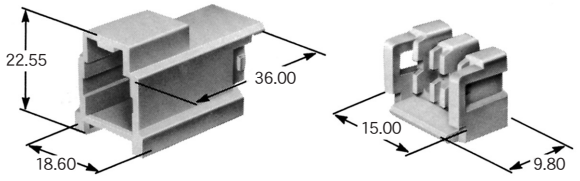
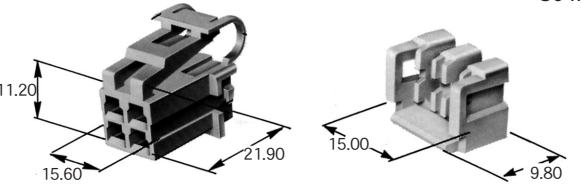
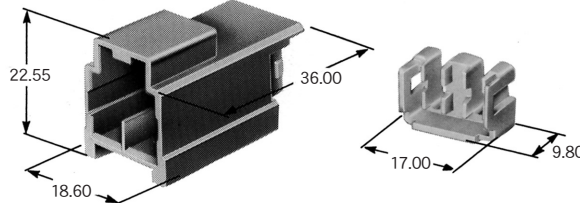
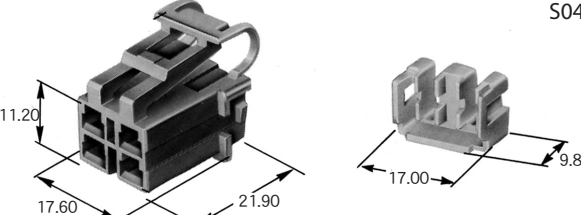
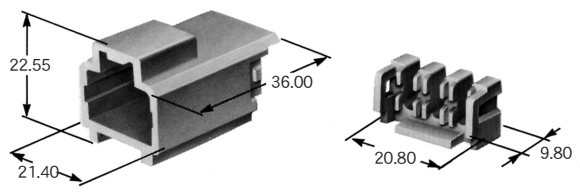
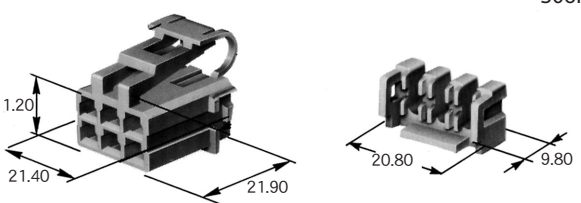
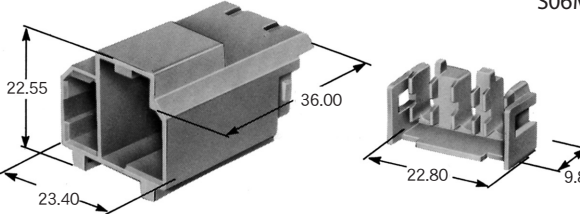
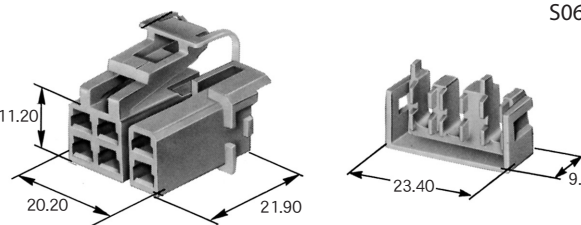
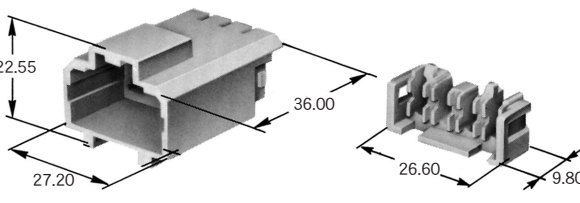
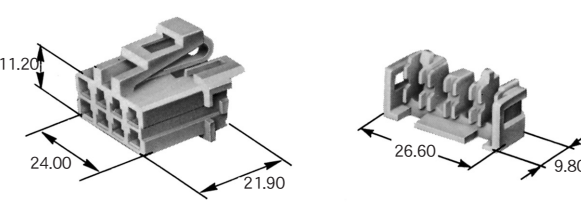
極数 POLES	M ハウジング MALE HOUSING	F ハウジング FEMALE HOUSING
3	 <p>S03ML 7122-1639-90 (7157-6032-90)</p>	 <p>S03FL 7123-1639-90 (7157-6033-90)</p>
4	 <p>S04MW 7122-1640 (7157-6040-70)</p>	 <p>S04FW 7123-1640 (7157-6040-70)</p>
4	 <p>S04ML 7122-1649-90 (7157-6042-90)</p>	 <p>S04FL 7123-1649-90 (7157-6042-90)</p>
6	 <p>S06MW 7122-1660 (7157-6060-70)</p>	 <p>S06FW 7123-1660 (7157-6060-70)</p>
6	 <p>S06ML 7122-1669-90 (7157-6062-90)</p>	 <p>S06FL 7123-1669-90 (7157-6063-90)</p>
8	 <p>S08MW 7122-1680 (7157-6080-70)</p>	 <p>S08FW 7123-1680 (7157-6080-70)</p>

()は、リヤホルダ品番 REAR HOLDER PART NUMBER IN PARENTHESIS.

ハウジング材質: 6 ナイロン (※はPBT) HOUSING MATERIAL: NYLON6 (MATERIAL OF THE PART ※ IS PBT)

単位: mm UNIT: mm

極数 POLES	Mハウジング MALE HOUSING	Fハウジング FEMALE HOUSING
8	<p>S08ML</p> <p>7122-1689-90 (7157-6082-90)</p>	<p>S08FL</p> <p>7123-1689-90 (7157-6083-90)</p>
8	<p>S08MB</p> <p>7122-1683-30 (7157-6084)</p>	<p>S08FB</p> <p>7123-1683-30 (7157-6085)</p>
10	<p>S10MW</p> <p>7122-1700 (7157-6100-70)</p>	<p>S10FW</p> <p>7123-1700 (7157-6101-70)</p>
10	<p>S10ML</p> <p>7122-1709-90 (7157-6102-90)</p>	<p>S10FL</p> <p>7123-1709-90 (7157-6103-90)</p>
12	<p>S12ML</p> <p>7122-1729-90 (7157-6122-90)</p>	<p>S12FL</p> <p>7123-1729-90 (7157-6123-90)</p>
16	<p>S16ML</p> <p>※ 7122-1769-90 (7157-6162-90)</p>	<p>S16FL</p> <p>7123-1769-90 (7157-6163-90)</p>

()は、リヤホルダ品番 REAR HOLDER PART NUMBER IN PARENTHESIS.