

Product description	Snap-In IP40 female cable connector, Contacts: 4, 3.5 - 5.0 mm, unshielded, solder, IP40
Area	Snap-In IP40 series 719
Order number	09 9764 71 04

Illustration	Scale drawing	Contact arrangement (Plug-in side)

You can find the component part drawing on the next page.

Technical data

General values

Connector design	female cable connector
Connector locking system	snap
Termination	solder
Wire gauge (mm)	0.25 mm ²
Wire gauge (AWG)	AWG 24
Cable outlet	3.5 - 5.0 mm
Upper limit temperature	70 °C
Lower limit temperature	-25 °C
Customs tariff number	85369010

Electrical values

Rated current (40 °C)	3 A
Rated voltage	60 V
Rated impulse voltage	800 V
Pollution degree	1
Overvoltage category	II
Insulating material group	III
Insulation resistance	≥ 10 ¹⁰ Ω
EMC compliance	unshielded
Degree of protection	IP40
Mechanical operation	> 100 Mating cycles

Material

Contact material	CuSn (bronze)
Contact plating	Au (gold)
Contact body material	PA
Housing material	PA
REACH SVHC	CAS 7439-92-1 (Lead)

Product description	Snap-In IP40 female cable connector, Contacts: 4, 3.5 - 5.0 mm, unshielded, solder, IP40
Area	Snap-In IP40 series 719
Order number	09 9764 71 04

Component part drawing

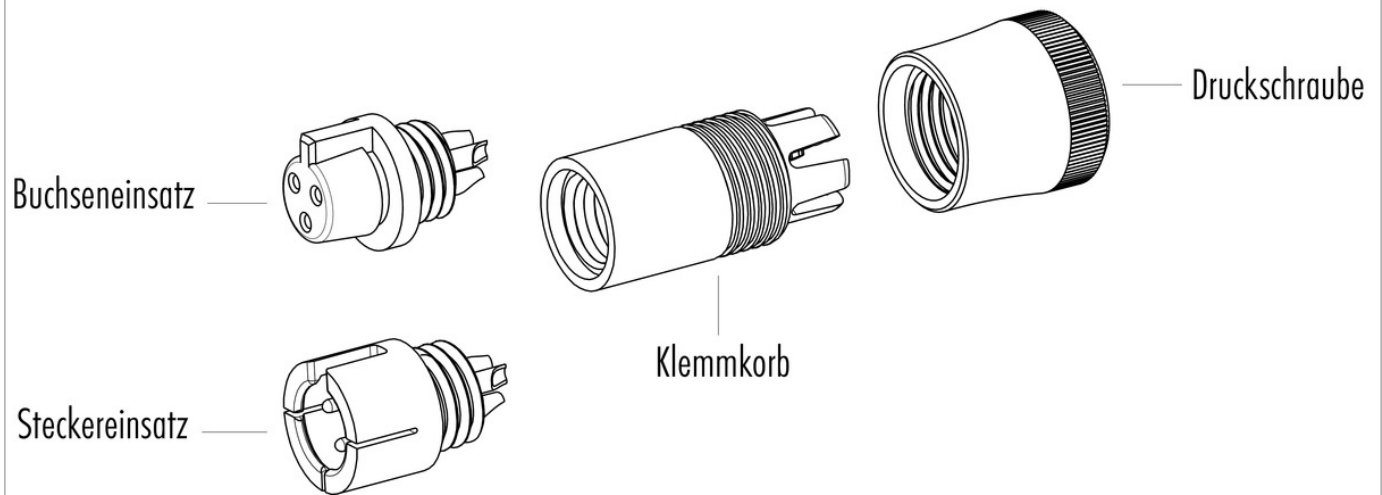

Product description **Snap-In IP40 female cable connector, Contacts: 4, 3.5 - 5.0 mm, unshielded, solder, IP40**

Area **Snap-In IP40 series 719**
Order number **09 9764 71 04**

Security notices

The connectors have been developed for applications in plant engineering, control and electrical equipment construction. The user is responsible for checking whether the connectors can also be used in other areas of application.